



- 193-24-BK
- 193-36-BK
- 196A-24-BK
- MA193-10-BK
- MA193-14-BK
- MA194-24-BK
- MN93-BK
- E94
- MN94
- MN193-BK
- MR193-BK
- SR193-BK
- SL261

CURRENT PROBES & SENSORS

(FOR POWER QUALITY METERS & POWER ENERGY LOGGERS)

Copyright© Chauvin Arnoux®, Inc. d.b.a. AEMC® Instruments. All rights reserved.

No part of this documentation may be reproduced in any form or by any means (including electronic storage and retrieval or translation into any other language) without prior agreement and written consent from Chauvin Arnoux®, Inc., as governed by United States and International copyright laws.

Chauvin Arnoux®, Inc. d.b.a. AEMC® Instruments
15 Faraday Drive • Dover, NH 03820 USA
Tel: (800) 945-2362 or (603) 749-6434 • Fax: (603) 742-2346

This documentation is provided "as is," without warranty of any kind, express, implied, or otherwise. Chauvin Arnoux®, Inc. has made every reasonable effort to ensure that this documentation is accurate; but does not warrant the accuracy or completeness of the text, graphics, or other information contained in this documentation. Chauvin Arnoux®, Inc. shall not be liable for any damages, special, indirect, incidental, or inconsequential; including (but not limited to) physical, emotional or monetary damages due to lost revenues or lost profits that may result from the use of this documentation, whether or not the user of the documentation has been advised of the possibility of such damages.

Statement of Compliance

Chauvin Arnoux®, Inc. d.b.a. AEMC® Instruments certifies that this instrument has been calibrated using standards and instruments traceable to international standards.

We guarantee that at the time of shipping your instrument has met its published specifications.

An NIST traceable certificate may be requested at the time of purchase, or obtained by returning the instrument to our repair and calibration facility, for a nominal charge.

The recommended calibration interval for this instrument is 12 months and begins on the date of receipt by the customer. For recalibration, please use our calibration services. Refer to our repair and calibration section at www.aemc.com/calibration.

Serial #: _____

Catalog #: _____

Model #: _____

Please fill in the appropriate date as indicated:

Date Received: _____











Date Calibration Due: _____



Chauvin Arnoux®, Inc.
d.b.a AEMC® Instruments
www.aemc.com

Thank you for purchasing an **AEMC® Instruments current probe**. For the best results from your instrument and for your safety, you must read the enclosed operating instructions carefully and comply with the precautions for use. Only qualified and trained operators should use this product.

Symbols & Definitions

	CAUTION - Risk of Danger! Indicates a WARNING. Whenever this symbol is present, the operator must refer to the user manual before operation
	Indicates a risk of electric shock. The voltage at the parts marked with this symbol may be dangerous
	Application or withdrawal authorized on conductors carrying dangerous voltages. Type A current sensor as per IEC 61010-2-032
	Refers to a type B current sensor. Application or withdrawal not authorized on conductors carrying dangerous voltages. Type B current sensor as per IEC 61010-2-032
	Signifies that the instrument is protected by double or reinforced insulation
	Battery
	The arrow indicates the phase of the current.
	Indicates important information to acknowledge.
	This product complies with the Low Voltage & Electromagnetic Compatibility European directives (73/23/CEE & 89/336/CEE).
	The UKCA marking certifies that the product is compliant with the requirements that apply in the United Kingdom, specifically regarding Low-Voltage Safety, Electromagnetic Compatibility, and the Restriction of Hazardous Substances.
	In the European Union, this product is subject to a separate collection system for recycling electrical and electronic components in accordance with directive WEEE 2002/96/EC.

Definition of Measurement Categories (CAT)

CAT IV corresponds to measurements performed at the primary electrical supply (< 1000 V).

Example: primary overcurrent protection devices, ripple control units, and meters.

CAT III corresponds to measurements performed in the building installation at the distribution level.

Example: hardwired equipment in fixed installation and circuit breakers.

CAT II corresponds to measurements performed on circuits directly connected to the electrical distribution system.

Example: measurements on household appliances and portable tools.



PRECAUTIONS FOR USE



The protection assured by the current probe can be compromised if it is used in a way that is not recommended by the manufacturer.

- Comply with the rated maximum voltage and current, and the measurement category. Do not use the current probe on networks where the voltage or category exceeds those specified.
- Comply with the conditions of use (e.g. temperature, humidity, altitude, degree of pollution, location).
- Do not use the current probe if its housing is open, deteriorated, or incorrectly reassembled. Before each use, check the integrity of the insulation of the unit, jaws, clamps, housing, and leads.
- Do not subject the current probe to water or other liquids.
- Keep the jaw contacts of the clamp absolutely clean.
- Use suitable personal protective equipment when hazardous voltages may be accessible in the installation where the measurement is made.
- Any repairs must be carried out by accredited skilled personnel.

TABLE OF CONTENTS

1. INTRODUCTION	7
1.1 Receiving Your Shipment.....	7
1.2 Ordering Information.....	7
2. PRODUCT FEATURES	8
2.1 Control Features.....	8
2.1.1 AmpFlex® Models 193-24-BK, 193-36-BK & 196A-24-BK.....	8
2.1.2 MiniFlex® Model MA193-BK.....	9
2.1.3 MiniFlex® Model MA194-BK.....	10
2.1.4 AC/DC Current Probe Model E94.....	11
2.1.5 AC Current Probe Models MN93-BK & MN193-BK.....	12
2.1.6 AC Current Probe Model MR193-BK.....	13
2.1.7 AC Current Probe Model SL261.....	14
2.1.8 AC Current Probe Model SR193-BK.....	15
2.1.9 AC Current Probe Model MN94.....	16
3. OPERATION	17
3.1 MR193-BK and SL261 Probes.....	17
3.2 Probes.....	18
3.3 AmpFlex® and MiniFlex® Sensors.....	18
3.4 E94 Clamp.....	19
4. SPECIFICATIONS	20
4.1 Electrical.....	20
4.2 Environmental.....	21
4.3 Mechanical.....	21
4.4 Safety.....	22
4.5 Conformity To International Standards.....	22
4.6 Electromagnetic Compatibility.....	22
5. MAINTENANCE	23
5.1 Cleaning.....	23
5.2 Battery Replacement.....	23
5.2.1 Model MR193-BK.....	23
5.2.2 Model SL261.....	23
5.3 Repair and Calibration.....	24
5.4 Technical Assistance.....	24
5.5 Limited Warranty.....	25
5.5.1 Warranty Repairs.....	25

1. INTRODUCTION

1.1 Receiving Your Shipment

Upon receiving your shipment, make sure that the contents are consistent with the packing list. Notify your distributor of any missing items. If the equipment appears to be damaged, file a claim immediately with the carrier and notify your distributor at once, giving a detailed description of any damage. Save the damaged packing container to substantiate your claim.

1.2 Ordering Information



NOTE: The current probes in this manual are compatible only with AEMC® Instruments Power Analyzers (see § 4 for meter compatibility).

AC/DC Current Probe Model SL261*	Cat. #1201.51
* Adapter for SL261 - BNC Adapter	Cat. #2140.40
AC Current Probe Model MR193-BK	Cat. #2140.28
AC Current Probe Model MN93-BK	Cat. #2140.32
AC Current Probe Model SR193-BK	Cat. #2140.33
AmpFlex® Sensor 24 in Model 193-24-BK	Cat. #2140.34
AmpFlex® Sensor 36 in Model 193-36-BK	Cat. #2140.35
AC Current Probe Model MN193-BK	Cat. #2140.36
MiniFlex® Sensor 10 in Model MA193-10-BK	Cat. #2140.48
MiniFlex® Sensor 14 in Model MA193-14-BK	Cat. #2140.50
AmpFlex® Sensor 24 in Model 196A-24-BK	Cat. #2140.75
MiniFlex® Sensor 24 in Model MA194-24-BK	Cat. #2140.80
AC Current Probe Model MN94	Cat. #2140.81
AC/DC Current Probe Model E94	Cat. #2140.82

2. PRODUCT FEATURES

2.1 Control Features

2.1.1 AmpFlex® Models 193-24-BK, 193-36-BK & 196A-24-BK

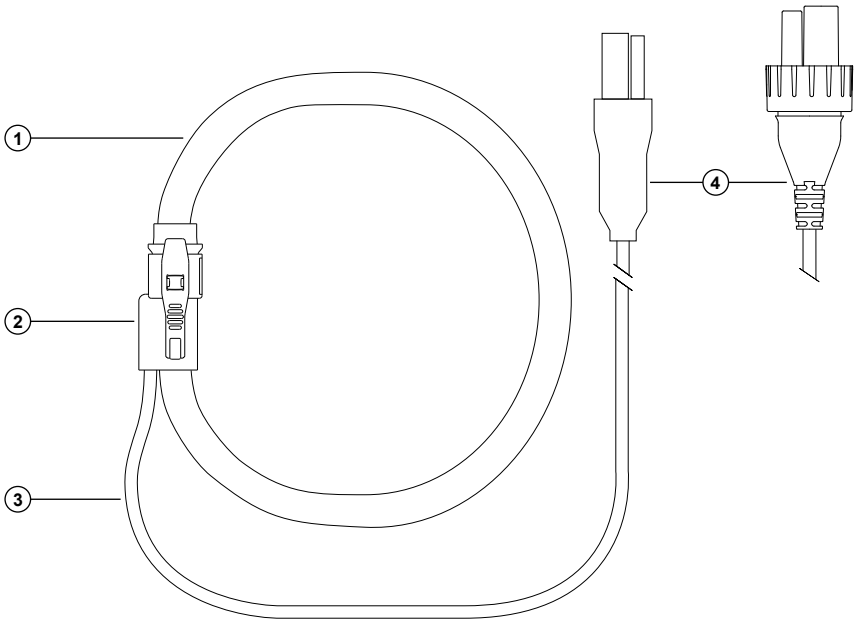

1. Flexible sensor
2. Sensor opening connector
3. Shielded lead
4. Custom 4-pin input connector (available standard or IP 67 compliant, depending on instrument)

2.1.2 MiniFlex® Model MA193-BK

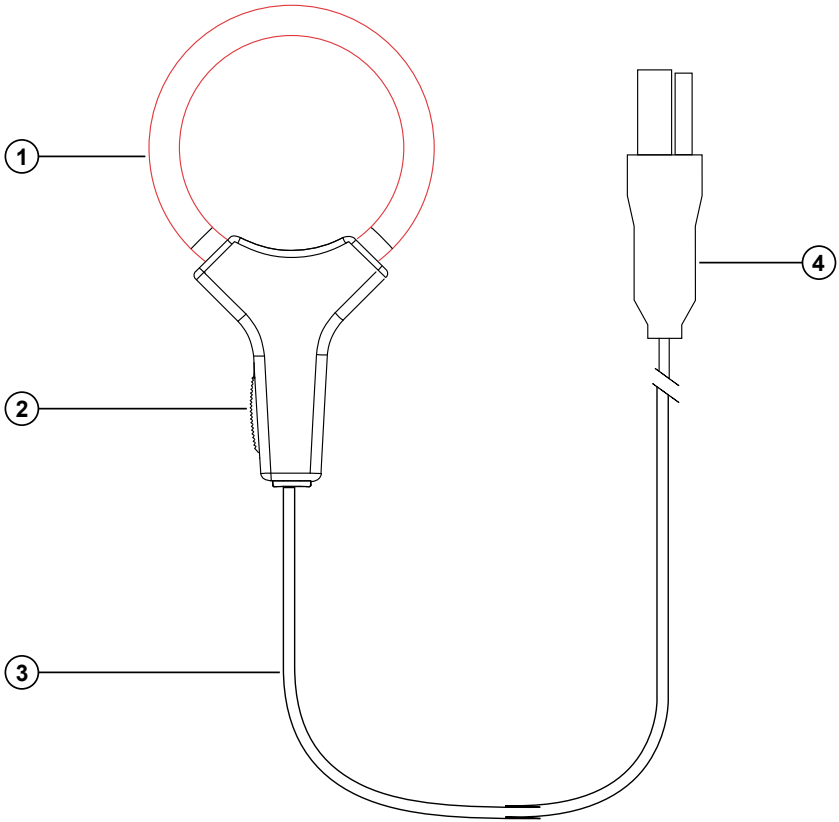

1. Flexible sensor
2. Sensor opening device
3. Shielded lead
4. Custom 4-pin input connector

2.1.3 MiniFlex® Model MA194-BK

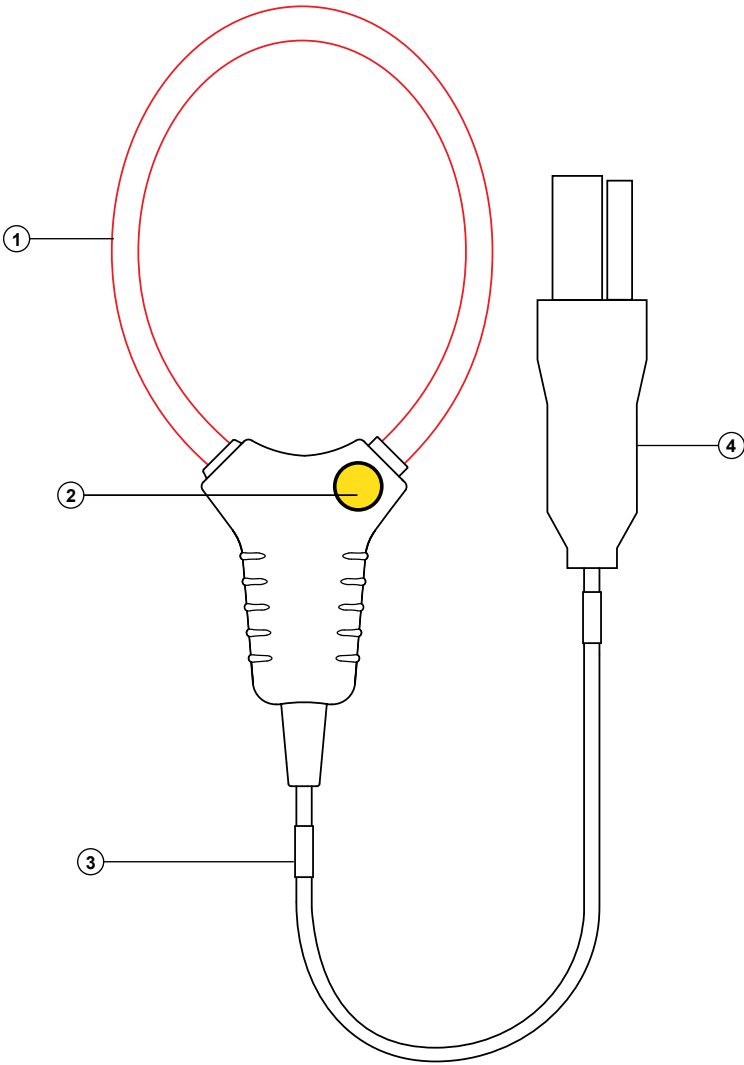

1. Flexible sensor
2. Sensor opening device
3. Shielded lead
4. Custom 4-pin input connector

2.1.4 AC/DC Current Probe Model E94

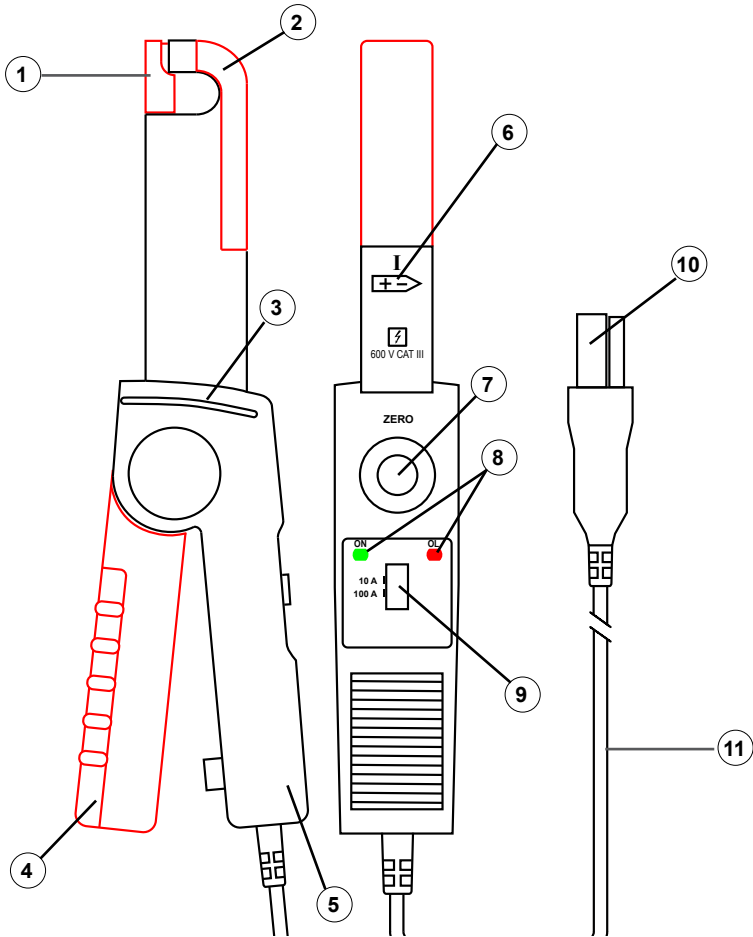

1. Mobile jaw
2. Fixed jaw
3. Guard
4. Mobile arm
5. Fixed arm
6. Arrow indicating the direction of current flow
7. Reset button
8. ON and OL indicators
9. Two-position slide switch
10. Special 4-point plug
11. Shielded cord

2.1.5 AC Current Probe Models MN93-BK & MN193-BK

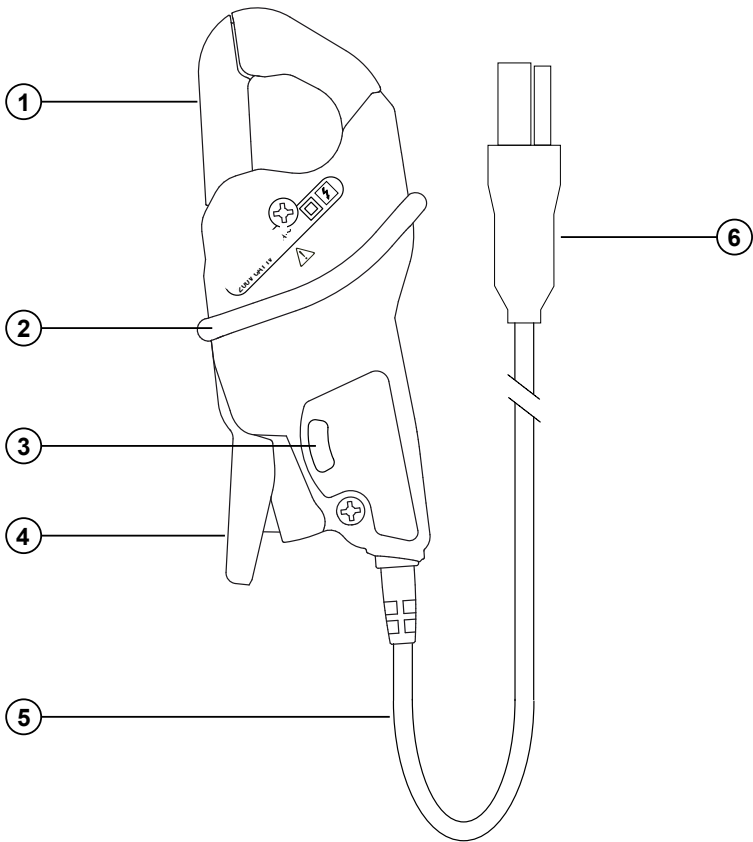

1. Jaws
2. Protective guard
3. Two-position range switch (MN193-BK only)
4. Jaw opening lever
5. Shielded lead
6. Custom 4-pin input connector

2.1.6 AC Current Probe Model MR193-BK

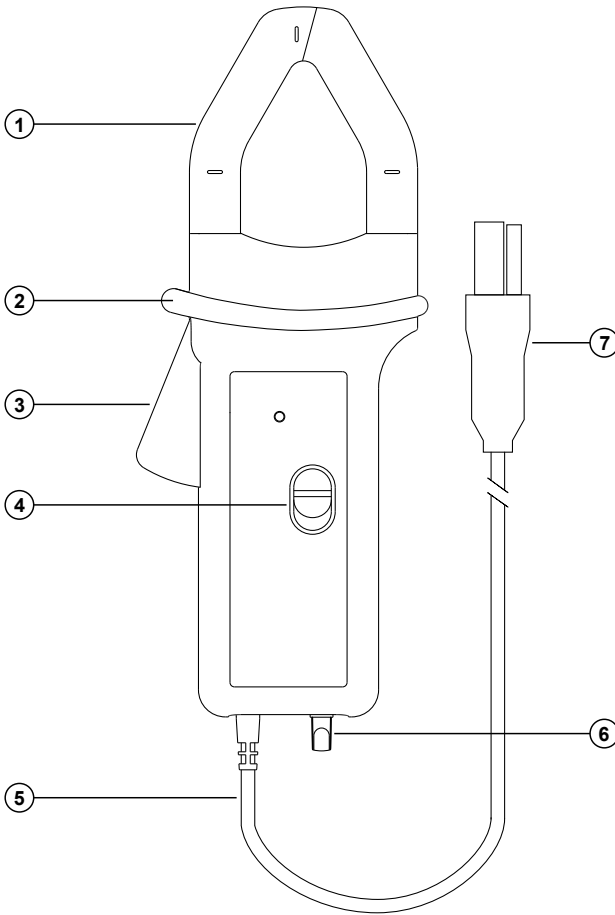

1. Jaws
2. Protective guard
3. Jaw opening lever
4. Two-position range switch
5. Shielded lead
6. Zero adjustment
7. Custom 4-pin input connector

2.1.7 AC Current Probe Model SL261

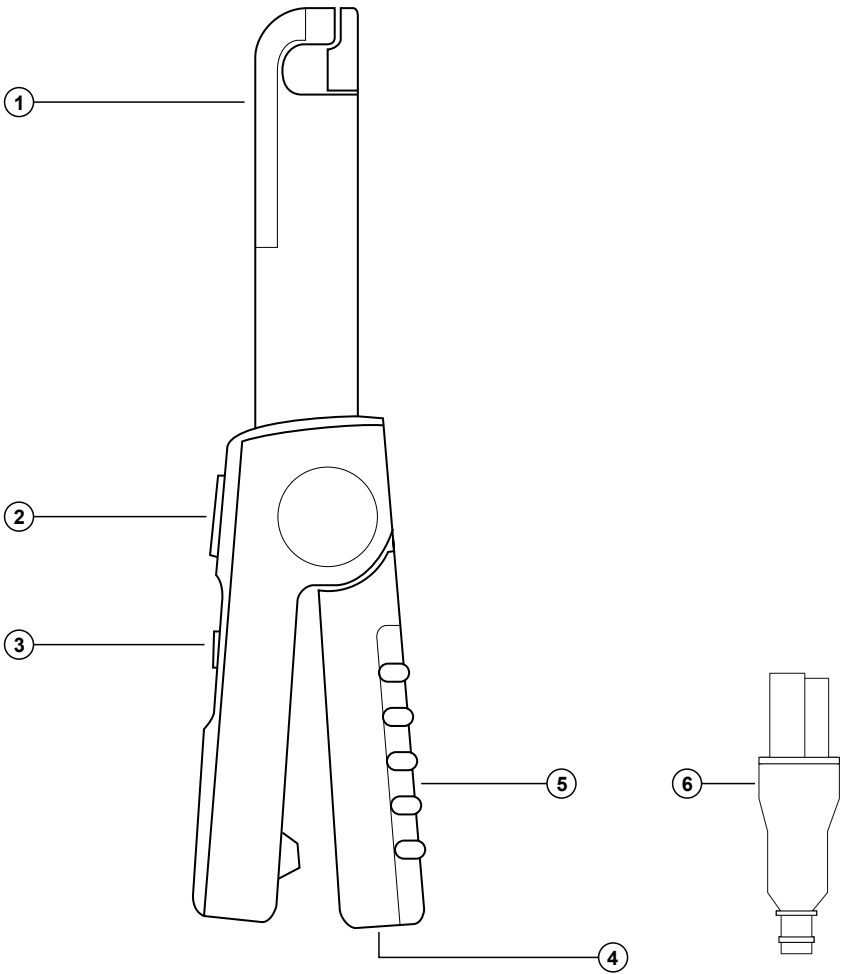

1. Jaws
2. Zero adjust knob
3. Range selection switch
4. Battery compartment screw
5. Battery compartment cover
6. BNC Adapter (sold separately - Cat. #2140.40)

2.1.8 AC Current Probe Model SR193-BK

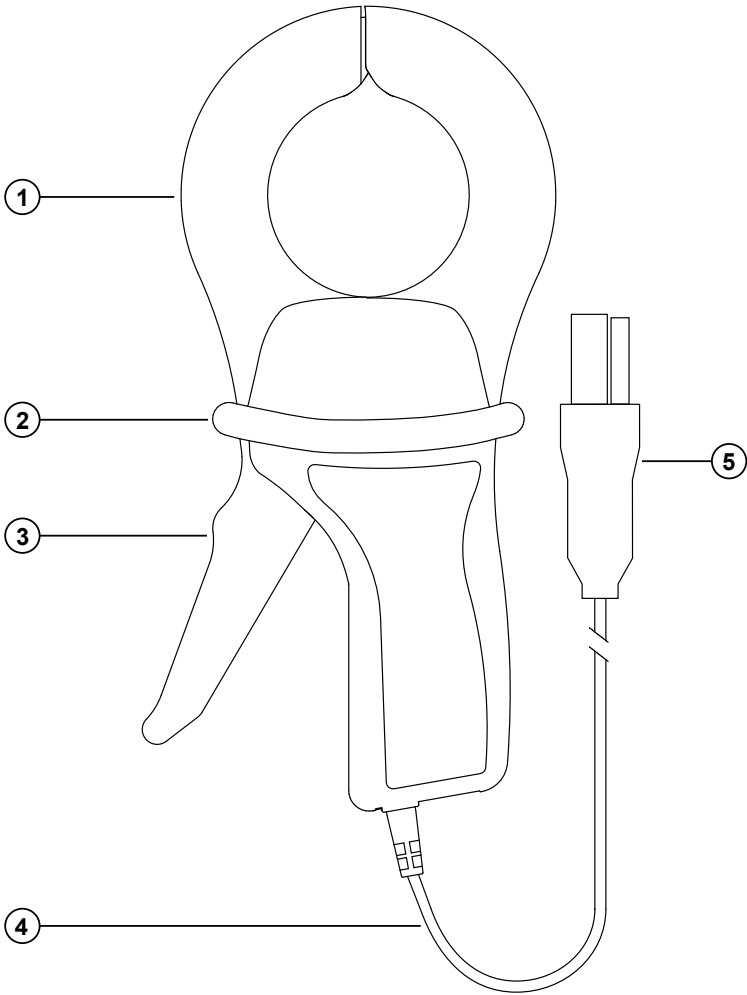

1. Jaws
2. Protective guard
3. Jaw opening lever
4. Shielded lead
5. Custom 4-pin input connector

2.1.9 AC Current Probe Model MN94

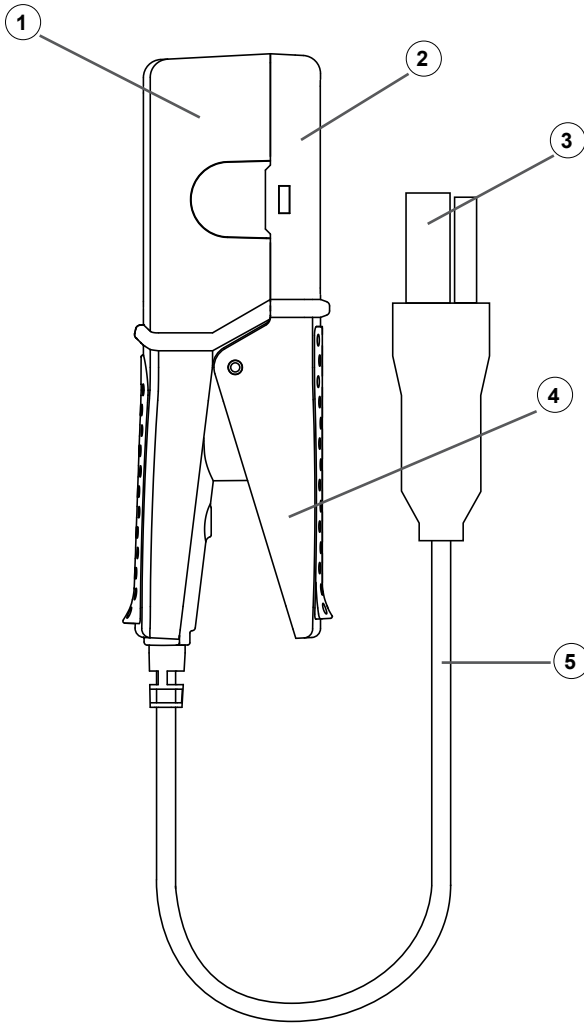

1. Fixed arm
2. Detachable arm
3. Special 4-point plug
4. Trigger
5. Shielded cord

3. OPERATION

The current probes and flexible sensors are used to measure the current flowing in a conductor or bus bar without opening the circuit. They also insulate the user from dangerous voltages in the circuit.

The choice of current probe or sensor to be used depends on the amperage to be measured and the diameter of the cables or size of the bus bar.

- For three-phase measurements, use the color-coded ID markers to associate a color for each current input to match the phase identifiers on the measured system.



NOTE: Always connect the probes or sensors with the indicating arrows pointing toward the load.

For Example Only (instrument's will vary):

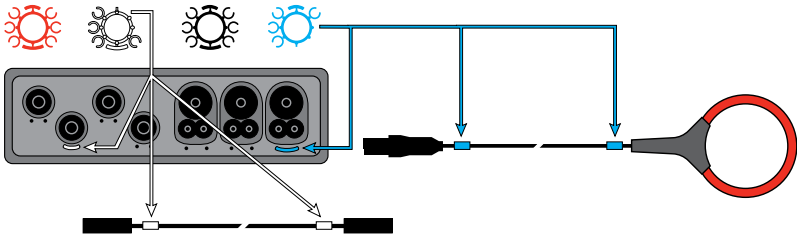

- Connect the current probe or sensor to the current terminals of the instrument.

3.1 MR193-BK and SL261 Probes

- **MR193-BK:** Set the switch to 1 mV/A; the ON indicator will light up.
SL261: Set the switch to 10 mV or 100 mV/A; the ON indicator will light up.
- Connect the probe to the instrument.
- Adjust the zero by turning the potentiometer with no conductor in the jaws of the clamp.
- When the measurement is finished, turn the probe switch to OFF.

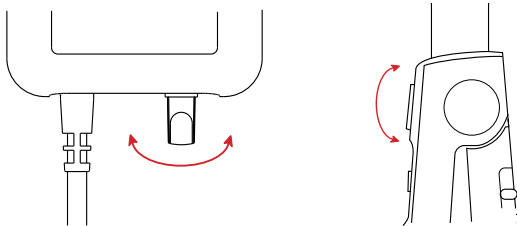

3.2 Probes

- Press the jaw opening lever on the probe to open the jaws.
- Clamp the probe around the conductor to be tested. For best results, center the conductor in the jaws of the clamp.

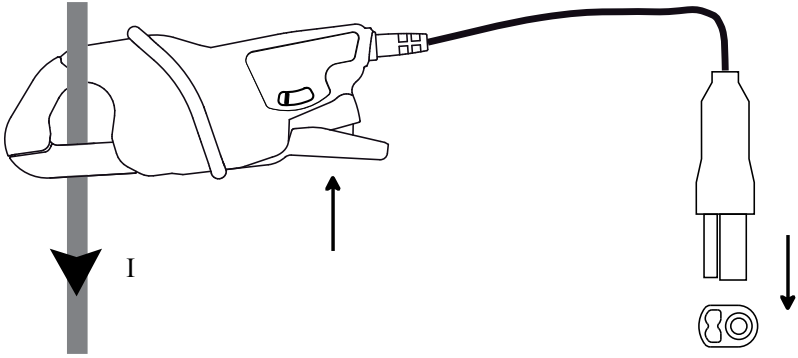

3.3 AmpFlex® and MiniFlex® Sensors

- AmpFlex®: Press simultaneously on both sides of the opening connector.
- MiniFlex®: Press the opening device to open the flexible sensor.
- Clamp the sensor around the conductor to be tested. For best results, center the conductor in the jaws of the clamp.

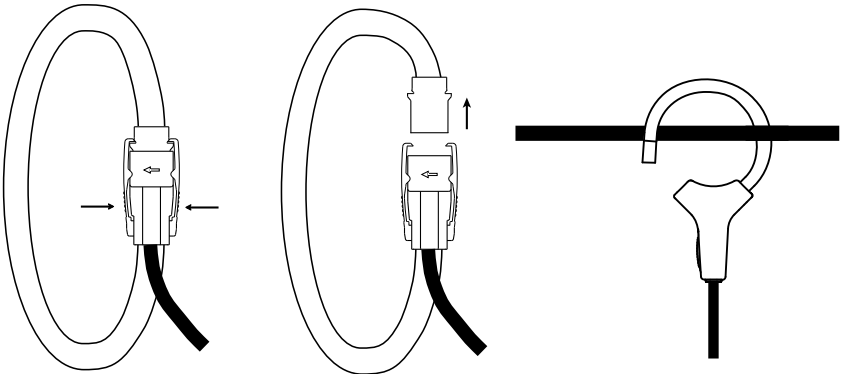

- Close the sensor by pushing the moving part into the connector until it clicks.

3.4 E94 Clamp

- Connect the clamp to the measuring instrument.
- Make sure that the clamp is not on a conductor and that its jaws are correctly closed.
- Place the clamp in the position it will be in during the measurement.
- Press the zero adjustment button.
- The **OL** indicator lights for approximately three seconds to indicate that the zero adjustment is in progress in the two ranges.
- If the zero has been correctly adjusted, the **OL** indicator goes off. If it remains on, the zero could not be adjusted.



NOTE: For details of the measurement configuration and technical specifications, refer to the user manual of the connected instrument.

4. SPECIFICATIONS

4.1 Electrical



NOTE: The measurement ranges specified are for the probes and sensors. In some cases, they may differ from the ranges that can be measured by the connected instrument.



NOTE: For complete specifications refer to the product user manual that is supplied with each compatible instrument.

Model	Measurement Range	Compatibility
AmpFlex® 193-24-BK ⁽¹⁾ 24 in (610 mm)	200 mA to 10 kAAC ⁽²⁾ (12,000 A) ⁽³⁾	All PowerPads and PEL 100 Series
AmpFlex® 193-36-BK ⁽¹⁾ 36 in (910 mm)	200 mA to 10 kAAC ⁽²⁾ (12,000 A) ⁽³⁾	All PowerPads and PEL 100 Series
AmpFlex® 196A-24-BK ⁽¹⁾ 24 in (610 mm)	200 mA to 10 kAAC ⁽²⁾ (12,000 A) ⁽³⁾	8435, 8436, and PEL 105
MiniFlex® MA193-BK ⁽¹⁾ 10 in (250 mm)	200 mA to 3000 AAC (10,000 A peak)	All PowerPads and PEL 100 Series
MiniFlex® MA193-BK ⁽¹⁾ 14 in (355 mm)	200 mA to 3000 AAC (10,000 A peak)	All PowerPads and PEL 100 Series
MiniFlex® MA194-BK ⁽¹⁾ 24 in (606 mm)	100 mA to 3000 AAC (10,000 A peak)	All PowerPads and PEL 100 Series
E94	10 A: 0.1 - 10 A peak 100 A: 0.5 to 100 A peak	8345
MN93-BK	2 to 240 AAC (I >200 A not permanent)	All PowerPads and PEL 100 Series
MN94	0.05 to 200 AAC	8345 and PEL 52
MN193-BK	5 A: 0.005 to 6 AAC 100 A: 0.1 to 120 AAC	PowerPads and PEL 100 Series
MR193-BK	10 AAC to 1000 AAC; 10 APEAK AC+DC to 1300 APEAK AC+DC	All PowerPads and PEL 100 Series
SL261	100 mV/A: 100 mA to 10 A peak 10 mV/A: 1 to 100 A peak	All PowerPads and PEL 100 Series
SR193-BK	1 AAC to 1200 AAC (I > 1000 A not continuously)	All PowerPads and PEL 100 Series

(1) 10 to 6500 AAC for Model 8435; 100 mA to 6500 A for Model 8436

(2) 200 mA to 10,000 A measurement range for the PEL 100 Series.

(3) 12,000 A is specified for the PEL 100 Series only.

Battery: 9 V Alkaline NEDA 1604 A, 6LR61

Battery Life: MR193-BK - 100 h typical
SL261 - 55 h typical



NOTE: Battery life is twice the typical value when using Lithium batteries.

4.2 Environmental

Indoor use

Operating Temperature: (14 to 131) °F (-10 to 55) °C; (10 to 85) % RH

Storage Temperature: (-40 to 158) °F (-40 to 7) °C; (10 to 90) % RH

Degree of pollution: 2

Altitude: < 2000 m

4.3 Mechanical

Model	Lead Length (nominal)	Clamping Diameter	Dimensions	Weight
AmpFlex® 193-24-BK 24 in (610 mm)	10 ft (3 m)	7.64 in (190 mm)	(6.6 x 6.2 x 0.98) in (170 x 158 x 25) mm	7.7 oz (270 g)
AmpFlex® 193-36-BK 36 in (910 mm)	10 ft (3 m)	11.46 in (290 mm)	(11 x 10.4 x 0.98) in (280 x 265 x 25) mm	9.5 oz (220 g)
AmpFlex® 196A-24-BK 24 in (610 mm)	10 ft (3 m)	7.64 in (190 mm)	(6.6 x 6.2 x 0.98) in (170 x 158 x 25) mm	7.7 oz (270 g)
MiniFlex® MA193 -10-BK 10 in (250 mm)	10 ft (3 m)	2.75 in (70 mm)	(4.0 x 2.5 x 1.1) in (103 x 64 x 28) mm	1.94 oz (55 g)
MiniFlex® MA193-14-BK 14 in (350 mm)	10 ft (3 m)	3.94 in (100 mm)	(4.0 x 2.5 x 1.1) in (103 x 64 x 28) mm	2.11 oz (60 g)
MiniFlex® MA194-24-BK 24 in (606 mm)	10 ft (3 m)	7.64 in (190 mm)	(4.0 x 2.5 x 1.1) in (103 x 64 x 28) mm	2.11 oz (60 g)
E94	10 ft (3 m)	.464 in (11.8 mm)	(9.09 x 1.41 x 2.65) in (231 x 36 x 67) mm	11.64 oz (330 g)
MN93-BK	10 ft (3 m)	0.8 in (20 mm)	(5.47 x 2.00 x 1.18) in (135 x 51 x 30) mm	24 oz (690 g)
MN94	10 ft (3 m)	0.63 in (16 mm)	(5.12 x 1.81 x 1.34) in (130 x 46 x 34) mm	8.82 oz (250 g)
MN193-BK	10 ft (3 m)	0.8 in (20 mm)	(5.47 x 2.00 x 1.18) in (135 x 51 x 30) mm	24 oz (690 g)
MR193-BK	10 ft (3 m)	One 1.6 in (42 mm) or two 0.98 in (25 mm) or two bus bars (1.96 x 0.19) in (50 x 5) mm	(8.8 x 3.82 x 1.73) in (224 x 97 x 44) mm	19 oz (540 g)
SL261	6.5 ft (1.9 m)	0.46 in (11.8 mm)	(9.09 x 1.42 x 2.64) in (231 x 36 x 67) mm	11.6 oz (330 g)
SR193-BK	10 ft (3 m)	2 in (52 mm)	(8.5 x 4.4 x 1.8) in (216 x 111 x 45) mm	24 oz (690 g)

4.4 Safety

Protection index IP 40 for the probes and IP 30 jaws open, according to IEC 60 529.

- IP 20 for E94 and MN94 clamps, according to IEC 60 529.
- IP 65 for the AmpFlex® according to IEC 60 529
- IK 04 according to IEC 50102

Drop test: According to IEC 61010-1

Electrical safety according to IEC 61010-2-032.

Maximum applicable voltage:

AmpFlex® 193-BK:	1000 V CAT III; 600 V CAT IV
AmpFlex® 196A-BK:	1000 V CAT IV
MiniFlex®-BK:	1000 V CAT III; 600 V CAT IV
E94:	600 V CAT III; 300 V CAT IV
MN93 /MN94/MN193-BK/ MN194-BK:	600 V CAT III; 300 V CAT IV
MR193-BK:	600 V CAT III; 300 V CAT IV
SL261:	600 V CAT III
SR193-BK:	1000 V CAT III; 600 V CAT IV

4.5 Conformity To International Standards

The instruments are compliant with IEC 61010-2-032.

The equipment is protected by double or reinforced insulation .

Type of current sensor per IEC 61010-2-032:

Type A  or Type B  for the Ampflexes.

4.6 Electromagnetic Compatibility

The instruments conform with standard IEC 61326-1.

Specifications are subject to change without notice.

5. MAINTENANCE

Use only factory specified replacement parts. AEMC® instruments will not be held responsible for any accident, incident, or malfunction following a repair done other than by its service center or by an approved repair center.



CAUTION: Risk of electric shock. Disconnect the instrument from any source of electricity.

5.1 Cleaning

- Use a soft cloth, dampened with soapy water. Rinse with a damp cloth and dry rapidly with a dry cloth.
- Do not use alcohol, solvents, or hydrocarbons.
- Do not splash water directly on the instrument.

5.2 Battery Replacement

5.2.1 Model MR193-BK

- Disconnect the MR193-BK completely and turn the rotary switch to OFF.
- Use a screwdriver to unscrew the screws and remove the battery compartment cover on the backside of the unit.
- Withdraw the battery from its compartment.
- Disconnect the old battery without pulling on the wires and replace with a new one, observing the polarity.
- Put the battery into its compartment.
- Put the cover back in place and screw the screws back in.

5.2.2 Model SL261

- Disconnect the SL261 completely and turn the rotary switch to OFF.
- Unscrew the battery compartment screw and pull off the battery compartment cover.
- Replace the battery with a new one, observing the polarity.
- Put the cover back in place and screw the screw back in.



Used batteries must not be treated as ordinary household waste. Recycle them appropriately.

5.3 Repair and Calibration

To ensure that your instrument meets factory specifications, we recommend that it be sent back to our factory Service Center at one-year intervals for recalibration or as required by other standards or internal procedures.

For instrument repair and calibration:

You must contact our Service Center for a Customer Service Authorization Number (CSA#). Send an email to repair@aemc.com requesting a CSA#, you will be provided a CSA Form and other required paperwork along with the next steps to complete the request. Then return the instrument along with the signed CSA Form. This will ensure that when your instrument arrives, it will be tracked and processed promptly. Please write the CSA# on the outside of the shipping container. If the instrument is returned for calibration, we need to know if you want a standard calibration or a calibration traceable to N.I.S.T. (includes calibration certificate plus recorded calibration data).

Ship To: Chauvin Arnoux®, Inc. d.b.a. AEMC® Instruments
15 Faraday Drive ▪ Dover, NH 03820 USA
Phone: (800) 945-2362 (Ext. 360) / (603) 749-6434 (Ext. 360)
Fax: (603) 742-2346
E-mail: repair@aemc.com

(Or contact your authorized distributor.)

Contact us for the costs for repair, standard calibration, and calibration traceable to N.I.S.T.



NOTE: You must obtain a CSA# before returning any instrument.

5.4 Technical Assistance

If you are experiencing any technical problems or require any assistance with the proper operation or application of your instrument, please call, e-mail or fax our technical support team:

Chauvin Arnoux®, Inc. d.b.a. AEMC® Instruments
Phone: (800) 343-1391 (Ext. 351)
Fax: (603) 742-2346
E-mail: techsupport@aemc.com
www.aemc.com

5.5 Limited Warranty

The instrument is warranted to the owner for a period of two years from the date of original purchase against defects in manufacture. This limited warranty is given by AEMC® Instruments, not by the distributor from whom it was purchased. This warranty is void if the unit has been tampered with, abused, or if the defect is related to service not performed by AEMC® Instruments.

Full warranty coverage and product registration is available on our website at www.aemc.com/warranty.html

Please print the online Warranty Coverage Information for your records.

What AEMC® Instruments will do:

If a malfunction occurs within the warranty period, you may return the instrument to us for repair, provided we have your warranty registration information on file or a proof of purchase. AEMC® Instruments will repair or replace the faulty material at our discretion.

REGISTER ONLINE AT: www.aemc.com/warranty.html

5.5.1 Warranty Repairs

What you must do to return an Instrument for Warranty Repair:

First, send an email to repair@aemc.com requesting a Customer Service Authorization Number (CSA#) from our Service Department. You will be provided a CSA Form and other required paperwork along with the next steps to complete the request. Then return the instrument along with the signed CSA Form. Please write the CSA# on the outside of the shipping container. Return the instrument, postage or shipment pre-paid to:

Chauvin Arnoux®, Inc. d.b.a. AEMC® Instruments
15 Faraday Drive, Dover, NH 03820 USA
Phone: (800) 945-2362 (Ext. 360) / (603) 749-6434 (Ext. 360)
Fax: (603) 742-2346
E-mail: repair@aemc.com

Caution: To protect yourself against in-transit loss, we recommend that you insure your returned material.



NOTE: You must obtain a CSA# before returning any instrument.

NOTES:

NOTES:



06/23
99-MAN 100391 v14

AEMC® Instruments

15 Faraday Drive • Dover, NH 03820 USA

Phone: (603) 749-6434 • (800) 343-1391 • Fax: (603) 742-2346

www.aemc.com