

BLU-D Series

Battery Load Unit

- Voltage range: 0 - 1020 V DC
- Discharge power - up to 15 kW
- Full battery discharge (to 0 V) prior recycling
- Temperature controlled discharge process
- Li battery discharge before transport
- Real-time test parameters monitoring on 7 inch touch screen display
- Enables testing batteries while in service
- USB, RS232 or Ethernet communication with PC



Description

DV Power BLU-D Series of Battery Capacity Testers is the latest DV Power solution for comprehensive battery capacity measurement. This universal instrument is applicable to any battery string (lead-acid, lithium-ion, nickel-cadmium based or other) with voltages **up to 1020 V DC**.

BLU-D Series simplifies battery testing in multiple ways. The instrument provides monitoring of discharge parameters (graphical and numerical) on **7 inch touch screen display**. Parameters such as battery voltage, capacity, test current / power / resistance and elapsed time can be monitored in real time. As an addition, the instrument enables measurement and monitoring of cell parameters (voltage/intercell voltage/temperature) with BVS system, which makes it a complete stand-alone discharge test system.

Besides the capacity test, BLU-D Series can be used to completely and efficiently discharge a battery down to 0 V. Such total discharge is applied to Li cells at the end of their lifetime, as the initial step of the **recycling process**.

BLU-D Series includes **2 models**:

- **BLU1000D**
- **BLU1000DZ**

Both models provides all features and options of the BLU-C Series, including discharge down to 0 V. The difference is related to the battery discharge below 5 V:

BLU1000D will discharge the battery by selecting minimum resistance (and current will decrease as the voltage decrease).

BLU1000DZ, having built-in Zero Voltage Discharge (ZVD) module, **provides constant current discharge (up to 50 A) down to 0 V**.

Transport of Li battery systems, due to safety reasons, requires batteries to be partially discharged. BLU-D Series provides special discharge mode enabling batteries to be discharged to customer predefined voltage level.

BLU-D Series can also be controlled by the DV-B Win software, enabling detailed numerical and graphical presentation of key parameters, including report creating in various formats.

Application

BLU-D Series typical application is measuring the capacity of batteries up to 1000 V DC.

Due to such high maximum operating voltage, any substation, industrial, UPS or EV battery can be tested.

Furthermore, BLU-D can be used to:

- Full discharge (down to 0 V) of any battery up to 1020 V DC prior recycling
- Monitor cell / intercell voltages during capacity / full discharge tests
- Discharge a battery before transport
- Provides temperature controlled discharge process (by measuring ambient / cell temperatures)

Capacity test

Using a BLU-D Series device, the capacity test is performed in an accordance to actual standards for battery testing (IEEE 450-2010 / IEEE 1188-2005 / IEEE 1106-2015, IEC 60896-11/22 and other relevant standards).

Discharging can be performed at constant current, constant power, constant resistance, constant voltage or in accordance with a pre-selected load profile. The discharge test can be carried out on online batteries as well (connected to its load). By measuring the total or load current by a DC probe, BLU-D enables keeping the total current / power constant during the test.

When a required discharge current or power exceeds the capacity of a single BLU-D device, several BLU-D devices can be connected in parallel.

BLU1000D & BLU1000DZ have identical discharge capabilities. Units provide maximum power (15 kW) on wide voltage range (125 – 1020 V DC). Maximum discharge currents (up to 120 A), in relation to the battery voltage, are presented on the graph below.

Maximum discharge power derates at ambient temperatures over 35 °C (up to 50 °C), as indicated by the blue area on the graph.

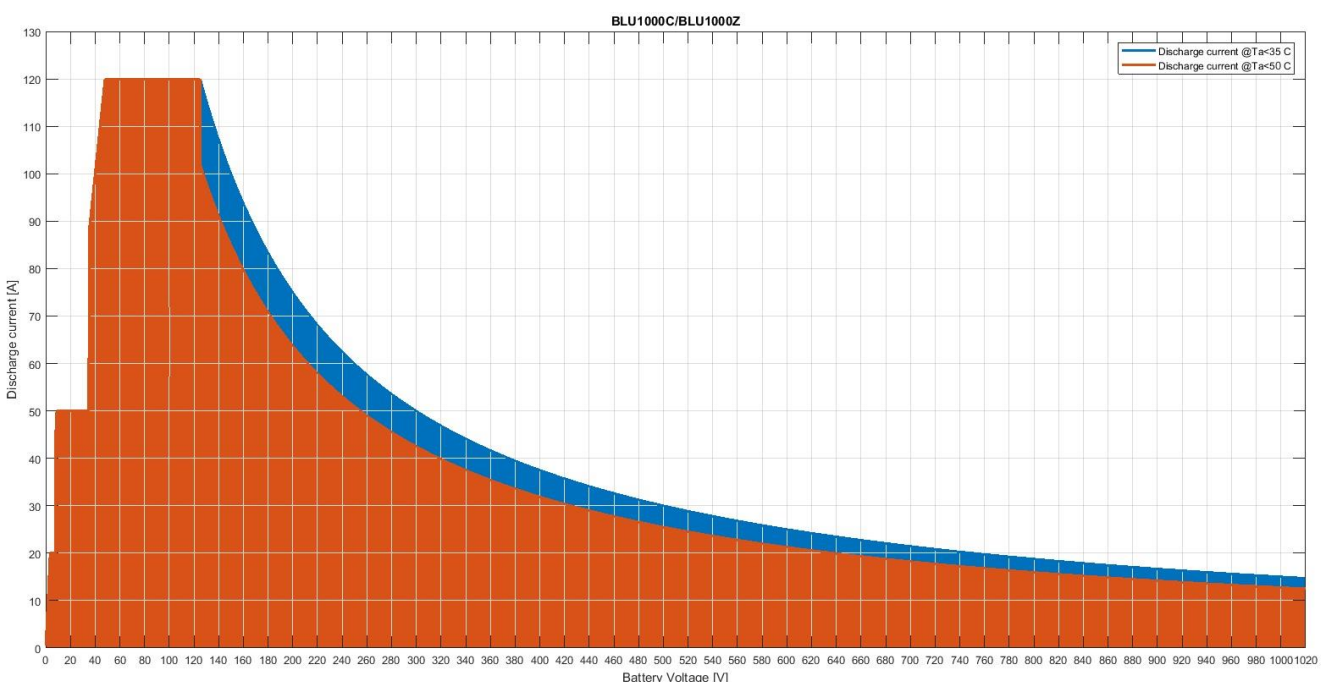

Battery recycling

BLU-D supports recycling, the battery waste management strategy for green energy. The initial step of the recycling process is a full battery discharge.

The unit provides efficient, controlled and complete battery discharge down to 0 V, which is applied to Li cells at the end of their lifetime. Wide voltage range (up to 1020 V) makes the unit applicable to any available battery system, including EV batteries. During the discharge, BLU-D models can monitor ambient as well as cell/module temperatures, enabling safe discharge process.

BLU1000DZ for efficient total discharge

BLU1000D and BLU1000DZ models provide full battery discharge (down to 0 V) feature. Main difference between the models is how the discharged process is managed on low battery voltages (< 5V).

BLU1000D will operate as constant resistance load – lower voltages implies lower discharge currents. However, the BLU1000DZ model has built-in *Zero Voltage Discharge (ZVD)* module enabling constant current discharge (up to 50 A) down to 0 V.

Battery discharge before transport

Transport of Li battery systems, due to safety reasons, requires batteries to be discharged down to 30% of their state of charge (SOC). BLU-D Series provides special discharge mode (*constant voltage mode*) enabling batteries to be discharged to customer predefined voltage level. The battery will be discharged by constant current until the preset voltage is reached. After reaching preset voltage, discharge continues at that voltage and the discharge current starts to decrease. The test will be stopped when discharge current decrease to the preset current limit.

A single discharge down to 0 V will not extract all the energy from the battery. Once the discharge is finished, battery voltage will rise to some non-zero value.

BLU1000DZ system improves the discharge process by discharging the battery in 2 steps:

Step 1: Efficient (up to 50 A) and controlled (current constant discharge) process until battery voltage drops to 0 V.

Step 2: ZVD short-circuits the battery to remove the remaining energy.

Connecting BLU-D to Battery

Single mode

The BLU-D device can be connected to any battery test object by using a set of current cables. To maximize the accuracy and measurement repeatability, all clamps must have good connection to the battery terminals while any crossing between the cables should be avoided. The BLU-D displays an appropriate message if connection between a cable clamp and the corresponding battery terminal is not established.

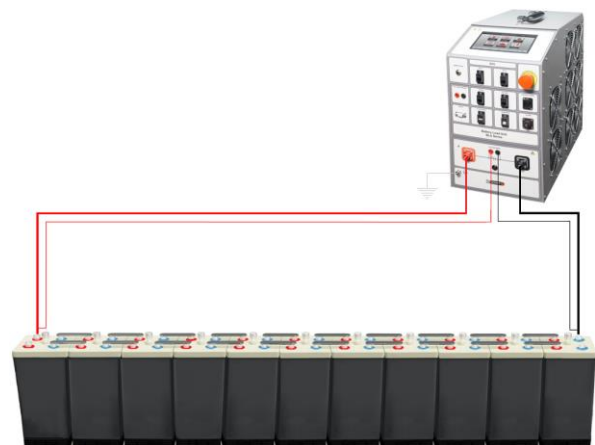

Parallel discharge test mode

In case the required current / power exceeds the capacity of a single BLU-D device, several (up to ten) BLU-D devices can be connected in parallel.

Connection between BLU-D devices is established by using Ethernet ports and RS485 communication. The communication is based on a MASTER-SLAVE principle – arbitrary selected device is set as MASTER while other units should be set as SLAVE units. All units connected (Master + up to ten Slave units) will discharge the battery equally – all units will be loaded with identical discharge current / power during the test.

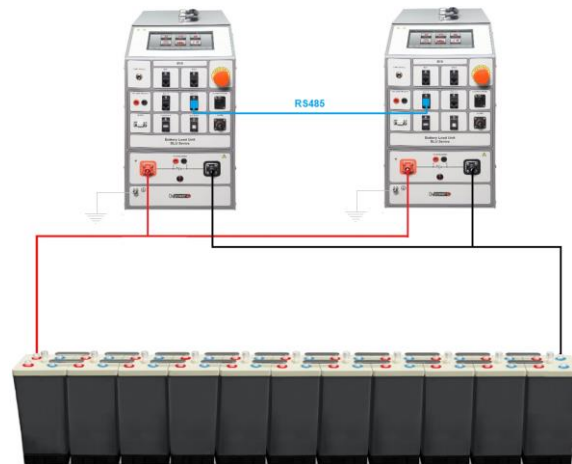

Current Probe mode

If the battery needs to supply its regular load continuously, the load current should be taken into account during the discharge test. Also, testing high-capacity battery strings may require engaging additional load units.

In both cases, the current probe should be used to enable BLU-D to regulate the total current / power.

The current probe can be connected in one of the following ways:

1. To measure the total discharge current (**Battery current mode**)

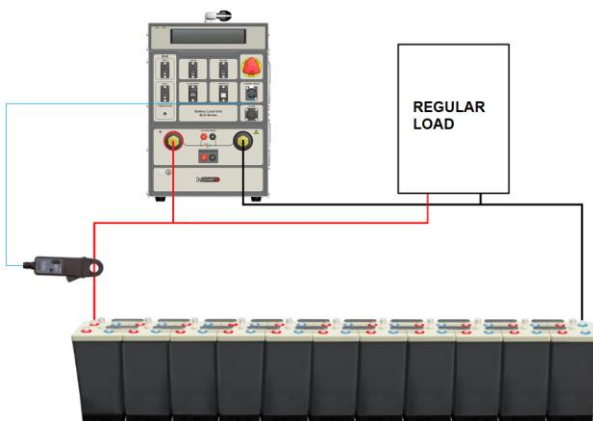

2. To measure the current of all additional loads (**Load current mode**)

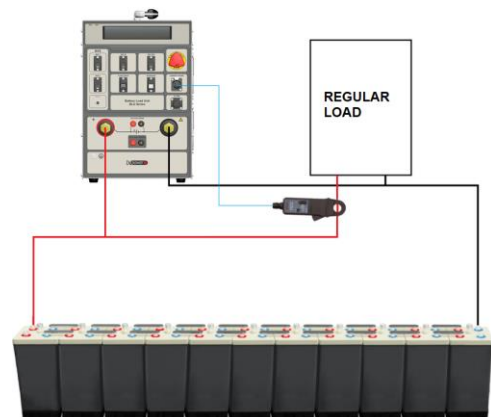

Benefits and Features

- Battery capacity measurement by conducting a discharge test
- Full battery discharge (down to 0 V) prior recycling
- Li battery discharge before transport (to preselected voltage)
- Temperature controlled discharge process
- *Constant I, Constant P, Constant R, Constant U* operation modes
- Several Load profile operation modes: *Load profile I, Load profile P* and *Load profile R*, enable simulating load characteristics variation during a discharge test
- Real-time test parameters monitoring on 7 inch touch screen display, including Voltage / Time and Capacity / Time graphs
- Cell parameters measurement and monitoring (voltage/intercell voltage/temperature)
- Parallel operation feature
- Remote Control feature: via built-in dry or wet contact, the test can be externally aborted.
- Enables testing batteries while in service
- Test resume feature in case of interrupted power supply

1 - Display - 7" color touch screen display

2 - Ambient Temperature Measurement

3 - Connection for BVS system for cell voltage / cell temperature / intercell voltage measurement

5 - External Load trigger - used for triggering BXL external load units

8 - Debug - service port

9 - Flash drive - used for transferring BLU memory data into an external memory stick and for SBC / firmware upgrade

14 - Protective Earth Connector - protective earth connector used to connect to protective ground (PE)

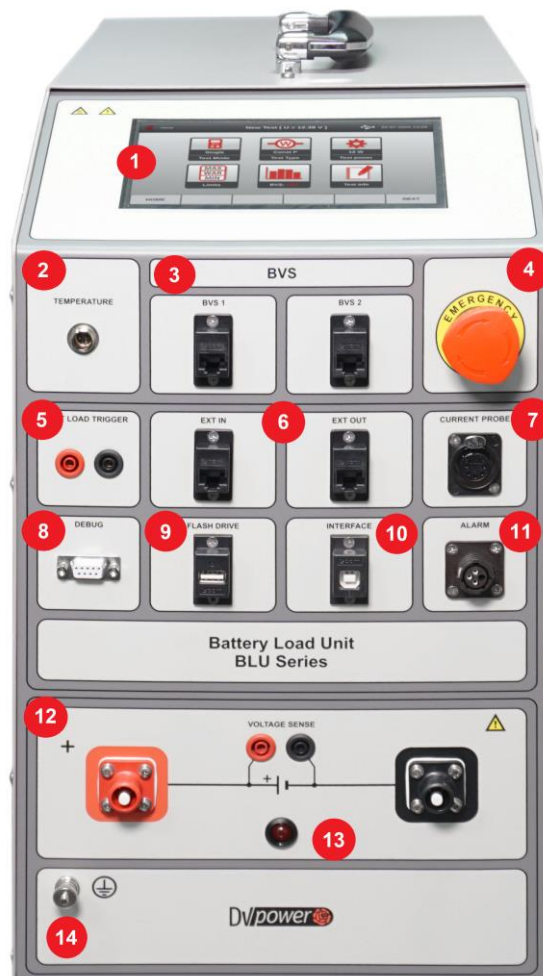

4 - Emergency STOP button - used when unexpected or unwanted action occurs.

6 - External input (EXT IN) and external output (EXT OUT) used for parallel operation OF BLU-D units

7 - Current probe - measuring load or total current bz using the external current probe.

11 - Alarm output or Remote Control

10 - Interface - USB, RS232 or Ethernet communication with a PC

12 - Current and Voltage terminals - current and voltage test cable terminals

13 - ZVD activation indication LED (BLU1000DZ only)

Cell Voltage Measurement Feature

Combining BLU-D and BVR22

Battery Voltage Recorder Series BVR22 is a lightweight, user-friendly, rechargeable handheld device intended for individual battery cell voltage and temperature measurement

while the battery is either in online or offline mode. When used in a system with the BLU-D device it serves as an efficient supplement to the battery capacity testing.

Options and features of the BVR22 model are presented in the table below.



	<p>Parameters Measured</p> <ul style="list-style-type: none"> - String and cell voltage, cell (electrolyte)/ambient temperature, DC current measurement using current clamps. - Simultaneous string voltage and DC current measurement - Bluetooth communication with external Density Meter <p>Measurement range</p> <ul style="list-style-type: none"> - String / Cell Voltage: ± 600 V DC - Current / Intercell voltage: ± 1 V DC <p>Data Transfer: Bluetooth and USB to PC</p>
---	--

Combining BLU-D and BVS

DV Power battery voltage supervisor – BVS, is an accurate battery voltage monitoring system that monitors the state of health of battery systems. It records important battery parameters such as battery voltage, inter-cell connection voltage, and ambient temperature. Therefore, it can be a support tool for BLU-D during

capacity testing. There are two types of DV Power battery voltage supervisors:

- BVS – One cell voltage module measures 1 cell
- BVS-4 – One cell voltage module measures 4 cells

Series	BVS	BVS-4
Picture		
No. of Measured Cells	One module measures one cell	One module measures four cells
Inter-cell Connection Voltage	✓	✗
Cell Temperature	YES (one temperature channel per cell)	YES (one temperature channel per 4 cells)
Ambient Temperature	✓	✓

Remote Control Feature (optional)

The discharge test on BLU-D units can be stopped externally. A BLU-D unit can have built-in dry or wet contact (depending on customer preferences), which can be used to stop the discharge when certain conditions are fulfilled.

If the dry-type contact is provided, changing the external circuit from close to open or from open to close, will signal the unit to terminate the test.

If the wet-type contact is provided, applying or cutting-off the voltage will signal the unit to terminate the discharge.

This feature enables automatic abortion of the discharge process when external systems detect and signal unregular conditions. For example, temperature increase detected by a monitoring system or thermal camera will stop the test and avoid safety issues.

DV-B Win Software

The DV-B Win software is included in the purchase price, and all its updates are free of charge. Using the DV-B Win software a test can be controlled, performed and observed from a PC (or notebook), and the results can be saved directly on a PC (or notebook). Communication between the BLU and a PC (or notebook) is achieved through a USB cable. Using DV-B Win the results can be arranged and printed for a report in a selectable format as an XLS, PDF,

Word, or RTF format. Also, the possibility of importing other types of data format (jpg, png, doc) into standardized DV-B Win report is provided, as well as exporting the numerical and graphical results from DV-B Win into customizable report. Additionally, the software provides a possibility of setting extra parameters (cell voltage, string voltage, capacity and time) for alarming and ending the test.

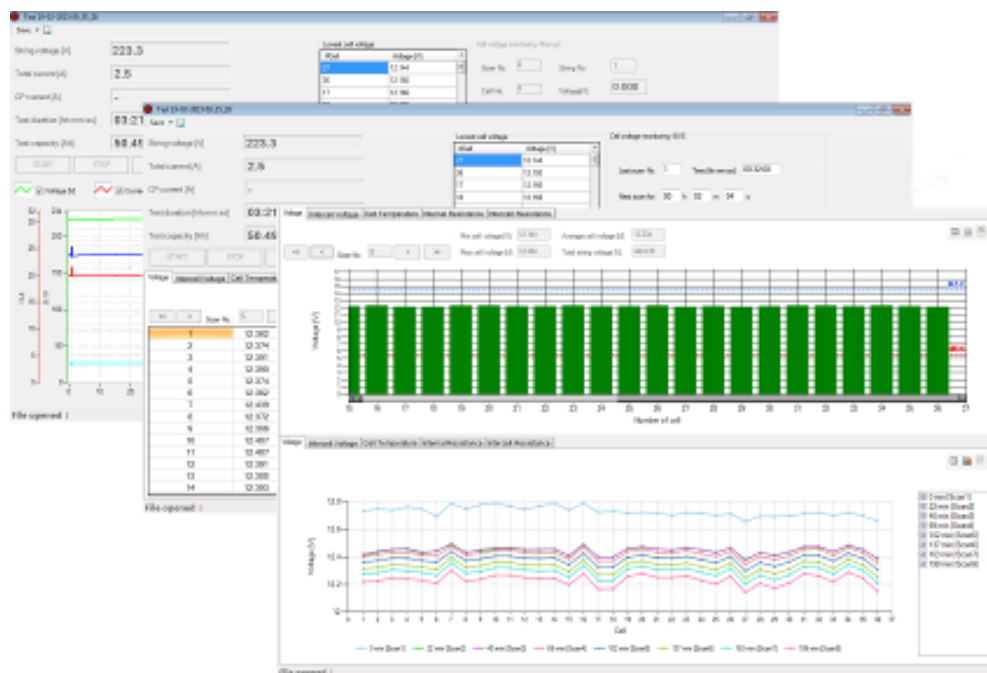

Technical Data

Mains Power Supply

- Connection according to IEC/EN60320-1; C320
- Voltage:
90 V – 264 V AC, 50 / 60 Hz, single-phase

Dimensions and Weights

Model	Dimensions	Weight
BLU1000D (without acc.)	520 x 260 x 436 mm 20.5 x 10.2 x 17.1 in	23,8 kg 52.5 lbs
BLU1000DZ (without acc.)		24,8 kg 54.7 lbs

Measurement

Internal current measurement

Model	Range	Resolution
BLU1000D & BLU1000DZ	0 – 200 A DC	0,1 A

Current measurement

- Display range: 0 – 2 999,9 A DC
- Basic accuracy: $\pm (0,5 \% \text{ of reading} + 0,1 \text{ A})$
- Resolution: 0,1 A

Internal voltage measurement & accuracy

Model	Range	Res.
BLU1000D & BLU1000DZ	0 – 1020 V DC	0,1 V

- Accuracy: $\pm 0,5\%$ of reading $\pm 0,1 \text{ V}$

Time measurement

- Typical accuracy:
 $\pm 0,1\%$ of reading $\pm 1 \text{ digit}$

Display

Size

- 7 inch color touch screen display

Range / Resolution

- Current: 0 – 2 999,9 A DC / 0,1 A
- Voltage: 0 – 1 999,9 V DC / 0,1 V
- Capacity: 0 – 9 999,9 Ah / 0,1 Ah
- Time: 00h:00m:00s - 23h:59m:59s / 1 sec

Input for current probe

- Range: 0 – 1 V DC
- Input impedance: $> 1 \text{ M}\Omega$

Communication

- USB
- RS232 (optional)
- Ethernet (optional)

Load section

- Battery voltage
0,0 – 1020 V
- Power:
0 – 15 kW
- Discharge modes:
Constant current / power / resistance / voltage; current, power or resistance profile mode

Available languages

- English, German, Italian, Polish, Croatian

Warranty

- 3 years + additional 1 (one) year upon registration on DV Power official website (www.dv-power.com).

STOP parameters

- Battery voltage
- Capacity
- Test time

Environment conditions

- Operating temperature:
-20 °C to +50 °C / -4 °F to +122 °F
- Storage & Transportation temperature:
-40 °C to +70 °C / -40 °F to +158 °F
- Relative humidity: up to 95%, non-condensing
- Pollution degree: 2

Protection

- Thermal cut-outs and automatic overload protection
- Emergency Stop button
- Overcurrent, overheat and overvoltage protection

Current probe specifications

Current probe	Ranges	mV/A – ratio	Supply
Current clamp 30/300 A*	30 A	10 mV / A	From the instrument
	300 A	1 mV / A	

* 1 000 A current clamp can be provided on request.

Encapsulation class / Ingress protections

- IP20

Applicable Standards

- IEEE 450-2010, IEEE 1188-2005, IEEE 1106-2015, IEC 60896-11, IEC 60896-22 and other relevant standards
- Electromagnetic Compatibility:
 - Directive 2014/30/EU (CE conform)
Applicable standard: EN 61326-1
- CAN/CSA-C22.2 No. 61010-1
- Safety
 - Low Voltage Directive: Directive 2014/35/EU (CE conform)
Applicable standards, for a class I instrument, pollution degree 2, Installation category II: IEC EN 61010-1

*All specifications herein are valid at ambient temperature of + 25 °C /+ 77°F and recommended accessories.
The company reserves the right to change the specification or design without prior notice.*

Accessories



Current cables



Extension cables



Sense cables with dolphin clips



Current clamp 30/300 A



BLU-BLU Communication cable



Cable bag



Transport case for BLU-D Series

Order Info

Instrument	Article No
Battery Load Unit BLU1000D	BLU1000-C-01
Battery Load Unit BLU1000DZ	BLU1000-Z-01

Included Accessories	Article No
Windows based DV-B Win PC software including USB cable	
Mains Power cable	MPC10A-EU-00
Ground (PE) cable	CABLE-GND-00
Transport case with wheels	HARD-CASE-C2W

Standard	Article No
Current cables 2 x 3 m* 25 mm ² (9.84 ft, 4 AWG) with alligator clamps (A4) isolated <i>for BLU1000D</i>	C2-03-25SL4I
Current cables 2 x 3 m* 25 mm ² (9.84 ft, 4 AWG) and sense cables 2 x 3 m* with alligator clamps (A4) isolated <i>for BLU1000DZ</i>	CS-03-25SL4I
Cable bag	CABLE-BAG-00

Optional	Article No
Battery Voltage Recorder BVR22	BVR22X-NN-00
Current cables 2 x XX m XX mm ² with alligator clamps (A4)	C2-xx-xxSL4I
Current cables 2 x XX m 25 mm ² (XX ft, 4 AWG) and sense cables 2 x XX m with alligator clamps (A4) isolated	CS-xx-254I
Extension current cables 2 x XX m XX mm ² (xx ft, xx AWG)	E2-xx-xxVA3I
Sense cables 2 x XX m (XX ft) with banana plugs + dolphin clip	S2-xx-00BPDC
Current clamp 30/300 A power supplied from the instrument	CACL-0300-06
Current clamp 1 000 A with internal battery supply and adapter	CACL-1002-02
Cell Voltage Module CVM	BVS-CVMNC-00
Cell Voltage Module CVM-4	BVS-CVM4N-00
Communication cable for CVM connection 1 x XX m	C1-xxxx-RJRJ
Voltage sense cable set 2 x XX m, 2 x XX m and 1 x XX m for CVM-4 with banana plugs + dolphin clip	Sxxx-00NN-DC
Voltage sense cable set 2 x XX m, 1 mm ² with banana plugs + dolphin clip	S-xxx-01BPDC
Cable for external alarm	CABLE-EXA-05
Cable for BLU-BLU parallel operation 3 m (9.84 ft)	CP-03RJ45-00
PT100 temperature indicator	TI-000-PT100
Plastic transport case for CVM (max. 50 pcs)	PLST-CAS-BV2
Plastic transport case for CVM modules (max. 15 pcs) and accessories	PLST-CAS-BV3
Cable plastic case	CABLE-CAS-0x

* Standard accessories include 3 m cables. Longer cables can be provided on request.

Contact

IBEKO Power AB

Lejonstigen 9
181 32 Lidingö
Sweden

Phone: +46 70 0925 000
E-mail: sales@dv-power.com